

# R&T

## ROUND FLUSH BUTTONS







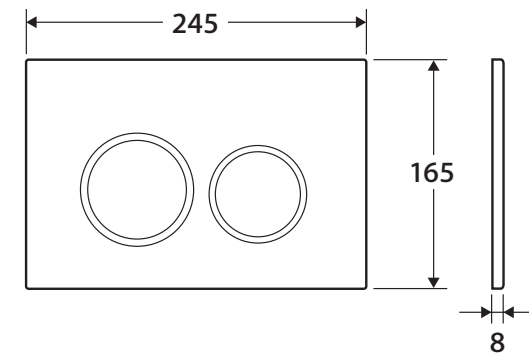

### Features

- For use with R&T cisterns only



### Available in

|   |   |   |
|---|---|---|
|   |   |   |
| Chrome<br>ABS Construction<br><b>JB11-C</b>   | Matte Black<br>ABS Construction<br><b>JB11-MB</b>                                     | Stainless Steel<br>SS Construction<br><b>JB11</b>                                     |
|  |  |  |
| PVD Brushed Nickel<br>SS Construction<br><b>JB11BN</b>                              | PVD Gun Metal<br>SS Construction<br><b>JB11GM</b>                                     | Urban Brass<br>SS Construction<br><b>JB11UB</b>                                       |

### Cleaning & Care

- Regularly clean with mild soapy water using a microfibre cloth.
- In highly polluted or coastal locations, we recommend cleaning 2-3 times per week.
- Do not use harsh detergents, bleach, cream cleaners or citrus based cleaners. These substances are abrasive and will damage the surface.
- Do not use undue pressure and wipe in one direction only.

While we aim to ensure specifications are correct at the time of publication, Fienza reserves the right to make modifications without prior notice. Physical colour may vary from image shown. All measurements are shown in millimetres. Always use physical product measurements for mark-ups and roughing-in as the technical drawing may differ from actual product received.